

This product is intended for installation only by expert users. Please consult with a qualified technician for installation. Improper installation may result in damage to your equipment.

Before you start using this product please follow these basic guidelines:

1. Please carefully read through the instruction manual before beginning the installation process.
2. Please remove your graphics card from your motherboard to insure the safest process and in order to prevent any possible damages to your CPU and motherboard.
3. It is strongly recommended to use market proven pre-mix coolant, such as Thermaltake Coolant 1000.

Parts List

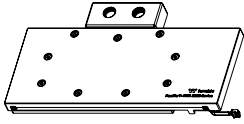

A x 1

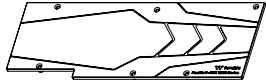

B x 1



C x 13



D x 2



E x 7



F x 6



G x 1



H x 5



I x 2



Use GeForce RTX 2080 WINDFORCE OC 8G as demonstration, other model reference the installation guide.

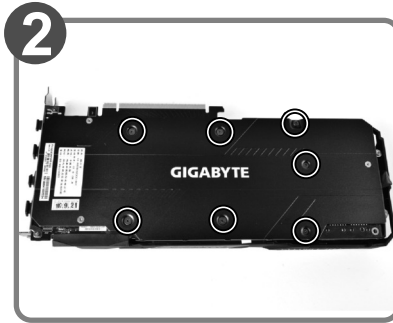

Remove original VGA stock cooler (Remove the screws circled on the diagram. All heat sink assembly screws should be removed)

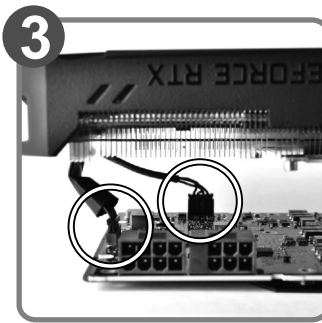

Remove the power connector (Carefully detach the original stock cooler)

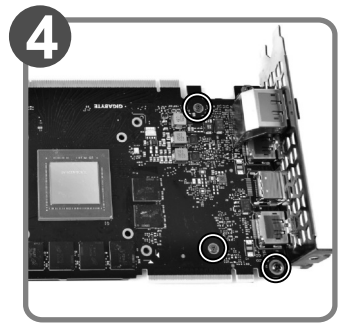

Clean the original thermal compound off the GPU die and remove the screws.

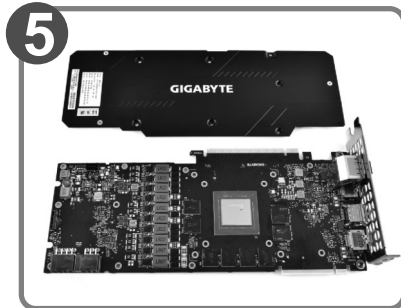

Detach the backplate.

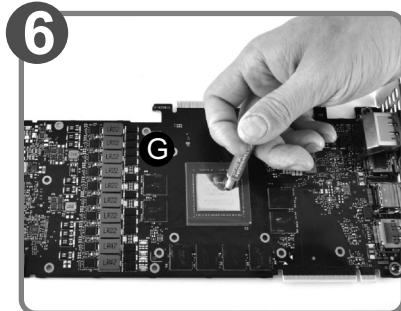

Apply thermal compound

7 Please confirm your VGA models before following the next step

Cut the thermal pads to the dimensions listed and place them on the spots shown on the diagram.

2080

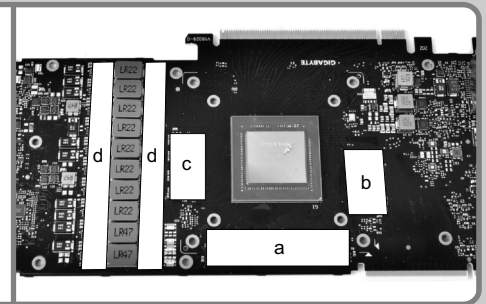
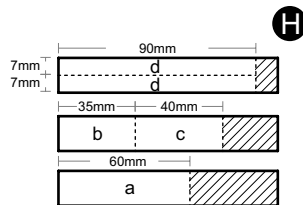

2080Ti

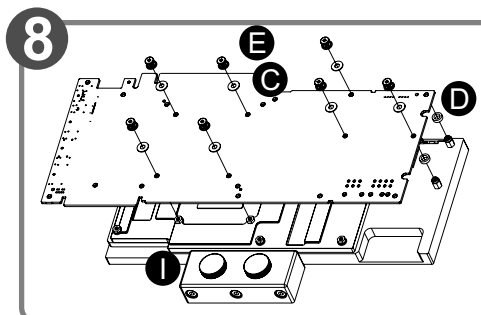
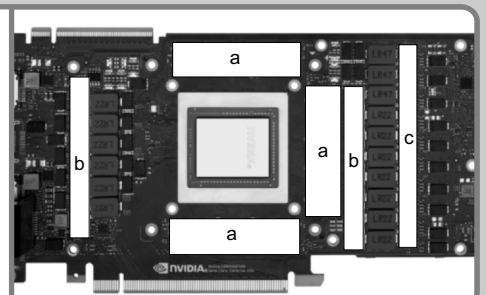
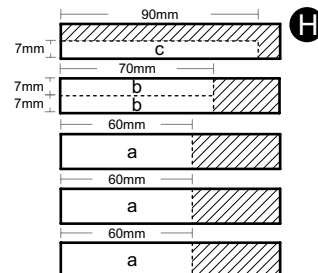

When installing the water block, carefully position the water block with the preinstalled standoffs on the graphics card.

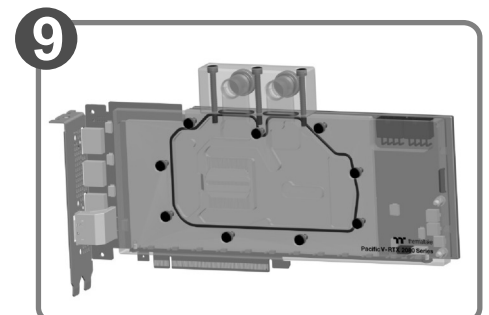
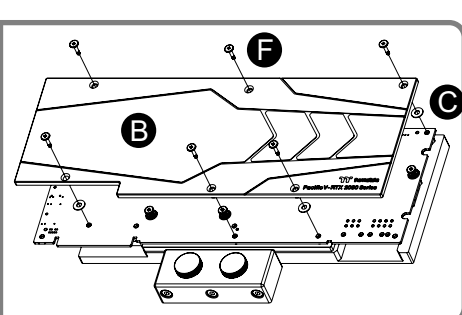

Finish

Parts List

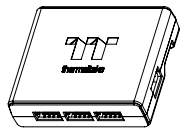

J x 1
Controller

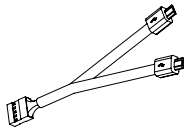

K x 1
Controller Cable

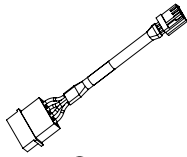

L x 1
Power Cable

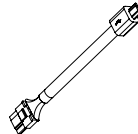

M x 1
Bridge Cable

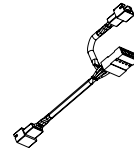

N x 1
LED Y-Cable

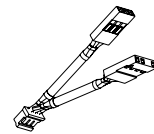

O x 1
MB SYNC Cable

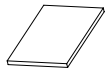

P x 1
Velcro

Installation Guide

10

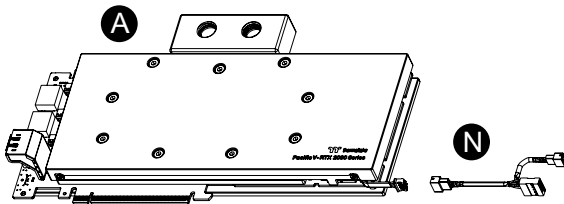

Connect the LED Y-Cable onto the waterblock.

11

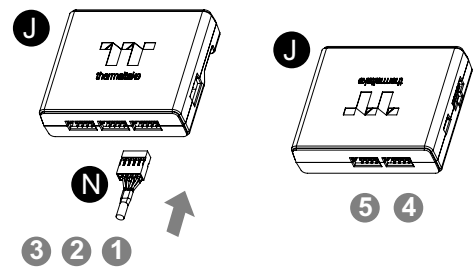

Connect the Waterblock onto the controller.

12

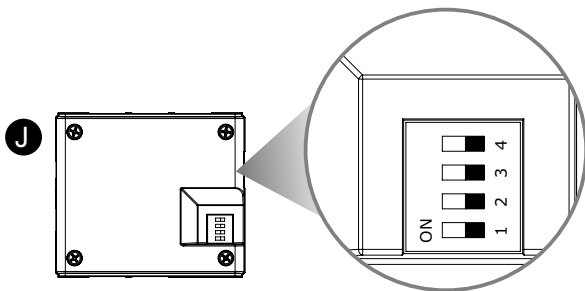

Set the DIP switch on the back side of the controller to assign the number of the controller

NO.1

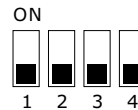

NO.2

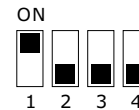

NO.3

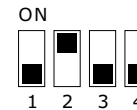

NO.4

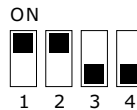

NO.5

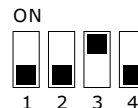

NO.6

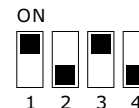

NO.7



NO.8

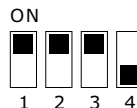

NO.9

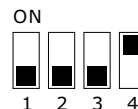

NO.10

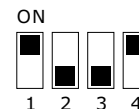

NO.11



NO.12

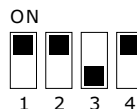

NO.13

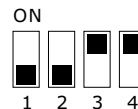

NO.14

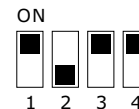

NO.15

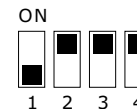

NO.16



13

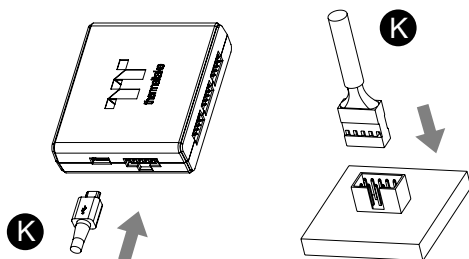

Connect the controller cable onto the mainboard (USB 2.0 9 pin) and controller.

14

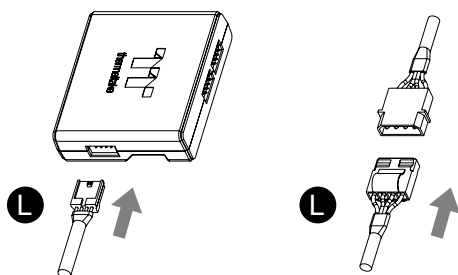

Connect the power cable to the 4pin Molex connector and controller.

15

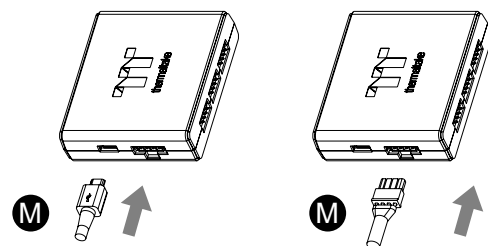

If you want to connect two or more connectors, you can use the bridge cable to connect the controllers.

Mianboard SYNC installation Guide

CAUTION

Please power off the PC and check the Positive and Negative ends on the connector before connecting the cable to mainboard. Connecting the wrong end can damage the LEDs.

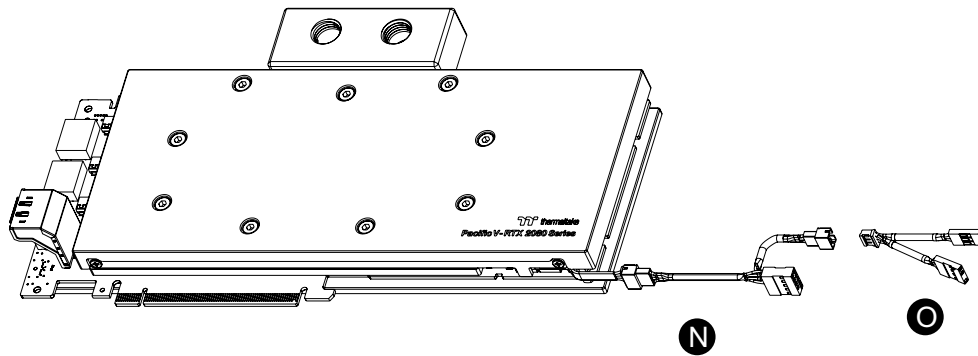
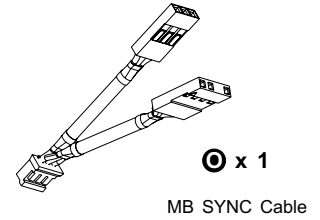
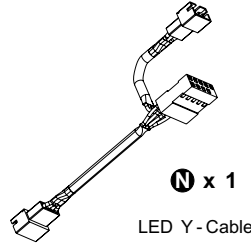

Connect the MB STNC Cable to Water block

ASUS

Aura Addressable Strip Header(s)

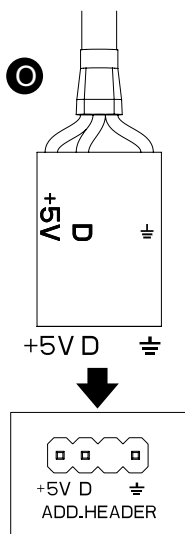

MSI

JRGB-strip Header(S)

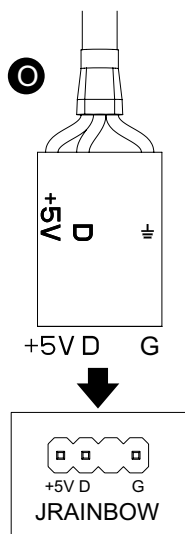

ASROCK

Addressable RGB LED Header(s)

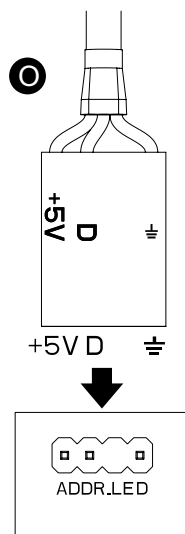

GIGABYTE

AOURS RGB Fusion with Digital LEDs

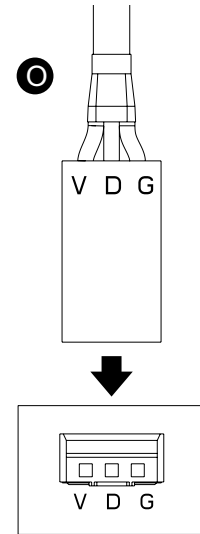

TT RGB Plus Software control interface

Please download software from Thermaltake Official website.

www.thermaltake.com/home.aspx

and search "TT RGB Plus" on the official website.

OS compatibility: Windows 7 / 8 / 8.1 / 10

When you open the software, choose the "VGA Plus" in the drop-down list(C-3) first.

1. Software User Interface

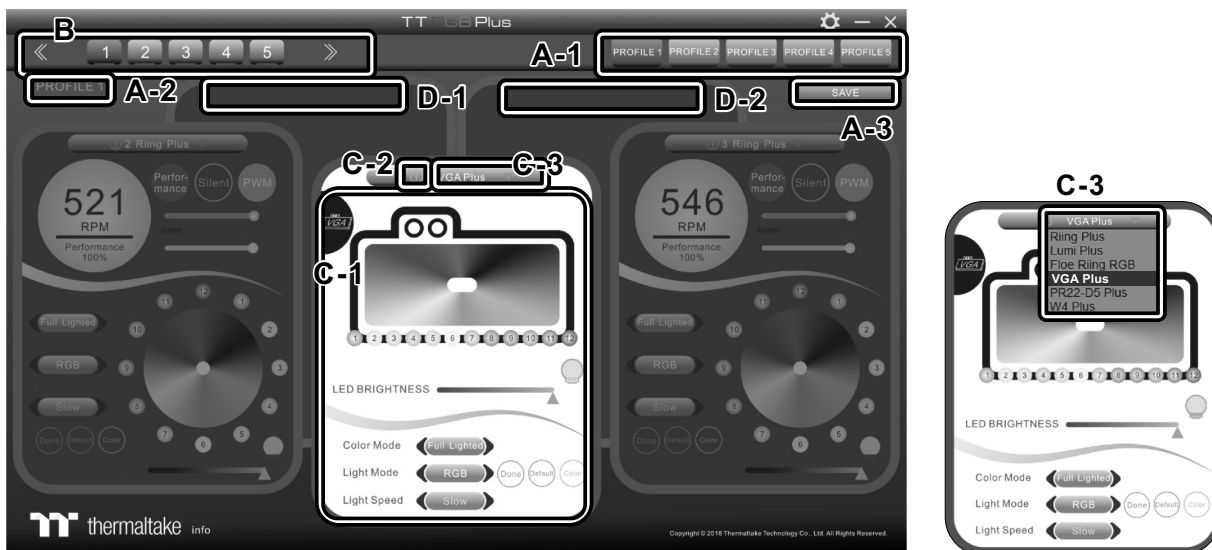

A. TT RGB Plus software Profile Setting

A-1 Set up a profile: Choose a Profile and set up the LED Lighting Mode, then click the SAVE icon(A-3) to store your settings to the software.

A-2 Save a profile to controller: Select a profile and a controller, then click the Save icon to assign the profile to the controller.

B. Follow the Installation Guide step 3, you can set up the number of the controller

C. LED Lighting Mode

Full Lighted / Wave / Pulse / Ripple / Blink / Sound Control / RGB Spectrum / Flow / Thermal...

C-1 LED Selection: set up the LEDs lighting, color, and speed .

Light Mode: Choose a lighting mode

Color Mode: Choose the LEDs color

Light Speed: Set up the speed of the LEDs light

LED Spot & Color Palette: Choose the color of each of the individual LEDs by clicking the color palette

Done: Save your setting

Default: Reset the LED setting back to the default

Brightness: Drag the mouse to adjust LED light brightness.

LED On/Off: Click the LED Light icon to turn on or off the LED light

RGB Color Code: Enter the Decimal Code of Red, Green, and Blue to set the LEDs color

C-2 LED On/Off: User can switch off the LED control function in the software if the fan is not plug into the controller.

C-3 Drop-down list: click the product name to choice another you want.

D-1 & D-2. Product Selection: click the control panel to rotate it to the front

2. Mobile APP Connection Password

To connect the Riing Plus RGB APP, please connect the PC to your wireless first, and click the Password setting under the software setting menu, set up your connection password. The TT RGB Plus APP will ask for your password every time when starting the APP.

For more information please visit www.thermaltake.com

