

This product is intended for installation only by expert users. Please consult with a qualified technician for installation. Improper installation may result in damage to your equipment. Before you start using this product please follow these basic guidelines:

1. Please carefully read through the instruction manual before beginning the installation process.
2. Please remove your graphics card from your motherboard to insure the safest process and in order to prevent any possible damages to your CPU and motherboard.
3. It is strongly recommended to use market proven pre-mix coolant, such as Thermaltake Coolant 1000.

Parts List

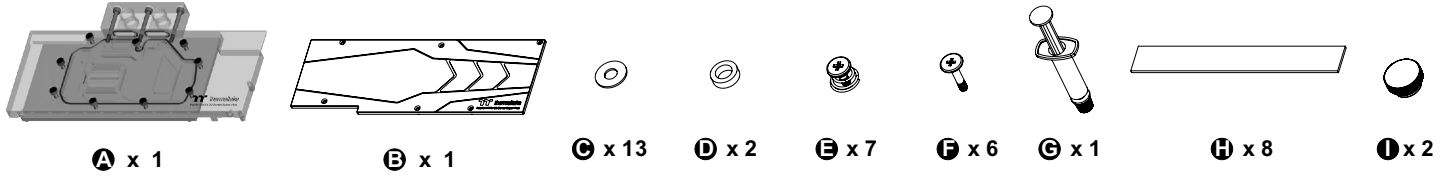

Use RTX 2070 Super as a demonstration, other model reference the installation guide.

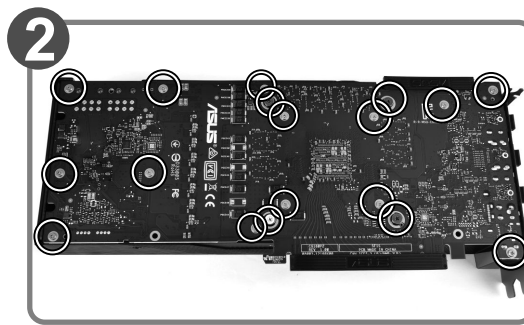

Remove the screws circled on the diagram. All heat sink assembly screws should be removed.

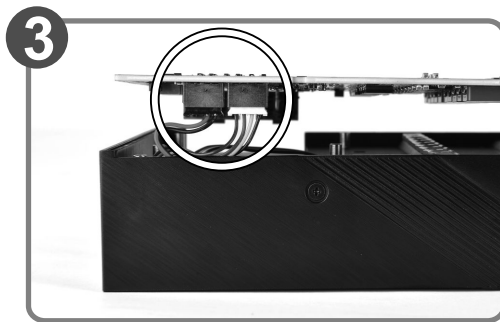

Remove the power connector (Carefully detach the original stock cooler)

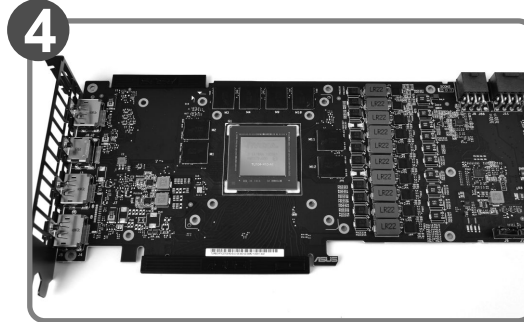

Clean the original thermal compound off the GPU die

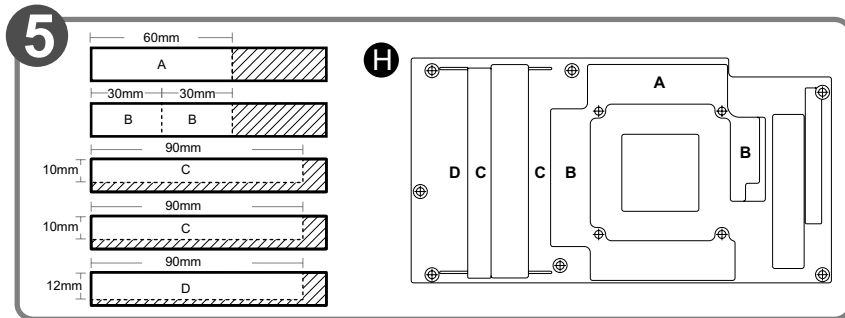

Cut the thermal pads to the dimensions listed and place them on the spots shown on the diagram.

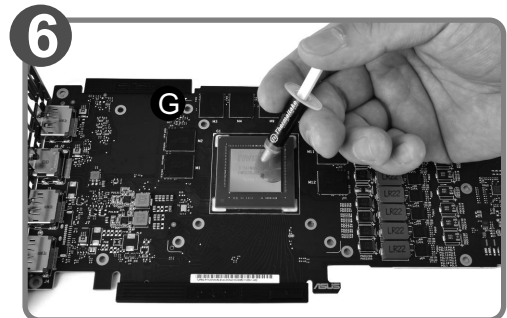

Apply thermal compound

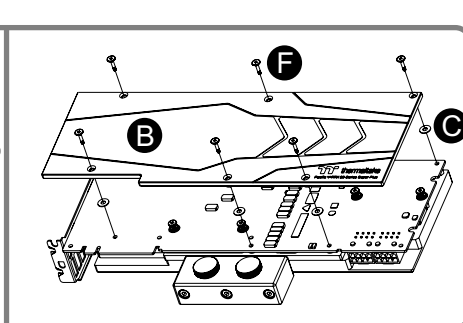
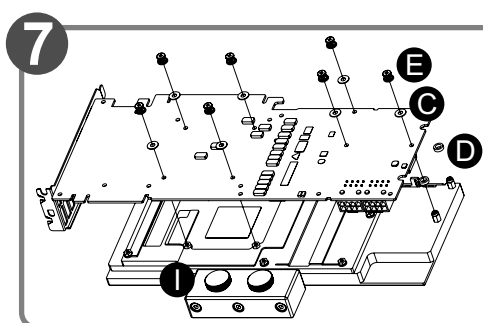

When installing the water block, carefully position the water block with the preinstalled standoffs on the graphics card.

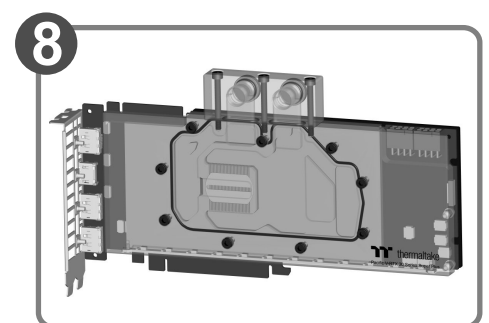

Finish

Parts List



J x 1
Controller

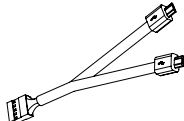

K x 1
Controller Cable

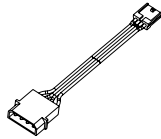

L x 1
Power Cable

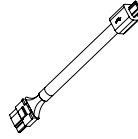

M x 1
Bridge Cable

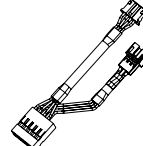

N x 1
LED Y-Cable

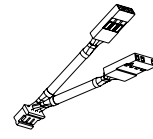

O x 1
MB SYNC Cable

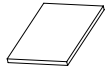

P x 1
Velcro

Installation Guide

9

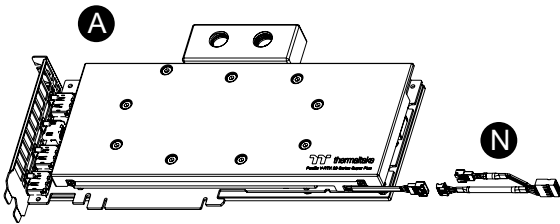

Connect the LED Y-Cable onto the waterblock.

10

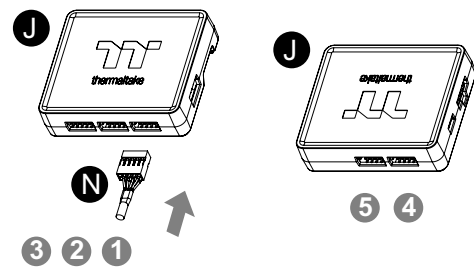

Connect the Waterblock onto the controller.

11

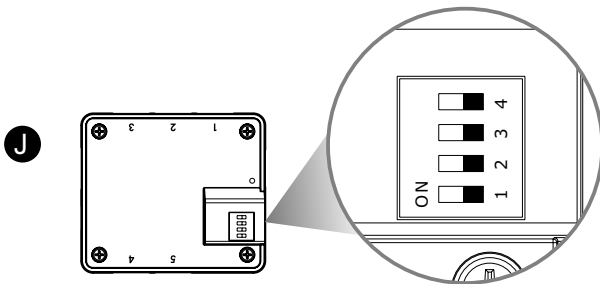

Set the DIP switch on the back side of the controller to assign the number of the controller

NO.1

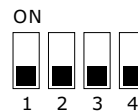

NO.2

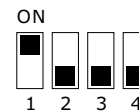

NO.3

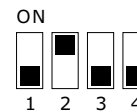

NO.4

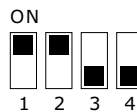

NO.5

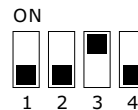

NO.6

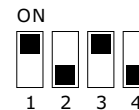

NO.7

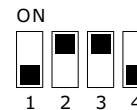

NO.8

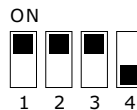

NO.9

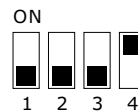

NO.10

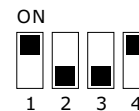

NO.11

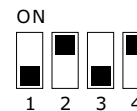

NO.12

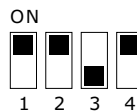

NO.13

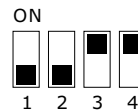

NO.14

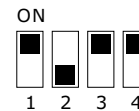

NO.15

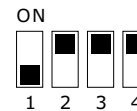

NO.16



12

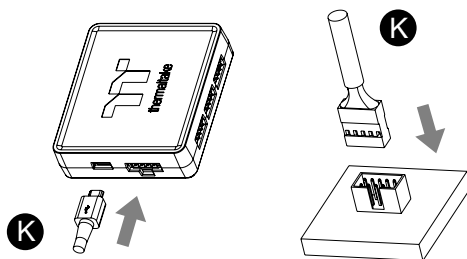

Connect the controller cable onto the mainboard (USB 2.0 9 pin) and controller.

13

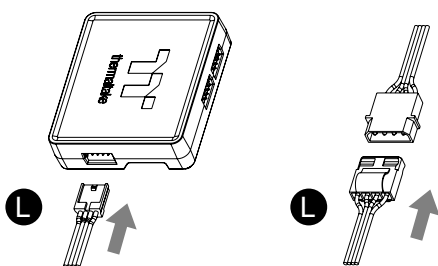

Connect the power cable to the 4pin Molex connector and controller.

14

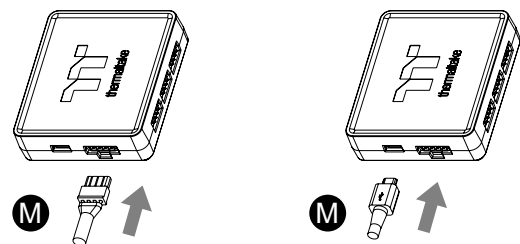

If you want to connect two or more connectors, you can use the bridge cable to connect the controllers.